



Programmer with fil pilote RDE100FP and auto timer

for heating systems

- For "Fil Pilote" 4-order system
- 3 "Fil Pilote" zones with time switch for each zone
- Choice of Comfort, Economy, Auto Timer and Stop mode
- Adjustable commissioning and control parameters
- Mains-powered AC 230 V

Use

The RDE100FP is used as a heating programmer.

Typical applications:

- Apartments
- Commercial spaces
- Schools

For the control of the following pieces of equipment:

- "Fil Pilote" radiators
- "Fil Pilote" equipment

Functions

- Selection of operating mode with touchkey
- Setting of Auto Timer (individual days, 7 days, or days 5-2)
- Display of current room temperature in °C or °F
- Touchkey lock (manually)
- Reloading factory settings for commissioning and control parameters
- Enabling operating mode for 3 zones

Type summary

Product No.	Stock number	Features
RDE100FP	S55770-T283	Mains-powered AC 230 V "Fil Pilote"

Ordering

When ordering, please indicate product No. / stock number and description:

Product No.	Stock number	Description
RDE100FP	S55770-T283	Programmer

"Fil Pilote" radiator must be ordered separately.

Mechanical design

The programmer consists of 2 parts:

- Plastic housing which accommodates the electronics, the operating elements and the room temperature sensor
- Mounting plate with screw terminals

The housing engages in the mounting plate and is secured with a screw.

Operation and settings



- 1) Touchkey for operating mode
- 2) Settings
- 3) Ok
- 4) Touchkey for decreasing a value
- 5) Touchkey for increasing a value

Display

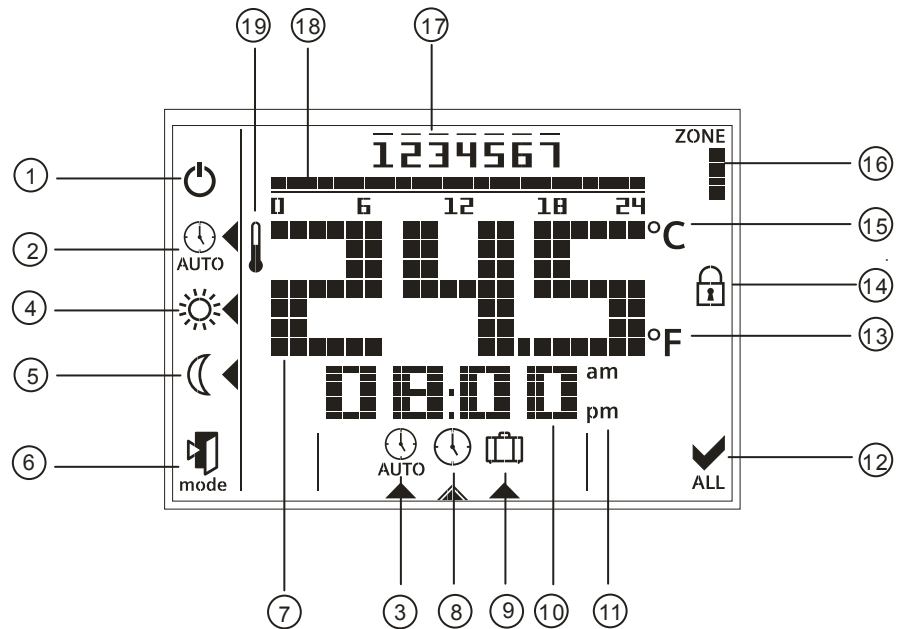

#	Symbol	Description	#	Symbol	Description
1		Stop mode	11	am pm	Morning: 12-hour format Afternoon: 12-hour format
2		Auto Timer mode	12		Confirmation
3		View and set time switches	13	°F	Room temperature in degrees Fahrenheit
4		Comfort mode	14		Touchkey lock activated
5		Economy mode	15	°C	Room temperature in degrees Celsius
6		Escape	16	ZONE 	Display of zone
7		Display of room temperature	17		Weekday 1 = Monday Weekday 7 = Sunday
8		Setting of weekday and time of day	18		Timer bar
9		Setting of Holiday mode	19		Current room temperature
10		Display of time of day			

Mounting and installation notes

In "Fil Pilote" systems, the temperature sensor used for the control is accommodated in the radiator itself. The internal sensor and the temperature display on the programmer are just for room temperature information. To ensure that this information is as accurate as possible, do not mount the programmer in niches or bookshelves, not behind curtains, not above or near heat sources, and not exposed to direct solar radiation. Mount it about 1.5 m above the floor.

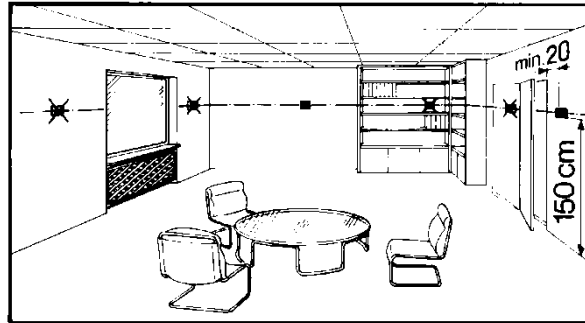

Mounting



Mount the programmer in a clean and dry location without direct air flow from heating/cooling equipment, and not exposed to drip or splash water.

Wiring

See Mounting Instructions CB1M1429xx enclosed with the programmer.



- Ensure that wiring, fusing and earthing comply with local regulations
- Correctly size the cables to the programmer and the radiators
- Use only radiators rated for AC 230 V
- If the programmer cannot accommodate all cables, power must be fed to the system via an external terminal block
- The AC 230 V mains supply line must have an external fuse or circuit breaker with a rated current of no more than 3 A (this rated current depends on the radiator's capacity)
- Disconnect from power supply before removing the unit from its mounting plate

Commissioning notes

Commissioning

After power is applied, the unit carries out a reset during which all LCD segments flash, indicating that the reset is correctly made. After the reset, the unit is ready for commissioning by qualified HVAC personnel.

The control parameters of the unit can be set to ensure optimum performance of the entire system (refer to Operating Instruction CB1B1426en, section "Do you want to change parameters?").

Sensor calibration

If the temperature on the display does not agree with the room temperature effectively measured, the temperature sensor can be recalibrated. For that purpose, adjust parameter P04.

Note

The displayed temperature is for information only. Room temperature control is ensured by the thermostat inside the radiator.

Operating notes

For each of the 3 zones, the RDE100FP provides Comfort, Economy and Auto Timer mode.

The changeover between Comfort and Economy mode can be made either automatically by the time switch or by pressing the touchkey for the operating mode.

Comfort mode ☼

When Comfort mode is activated, symbol ☼ appears on the display. The Comfort setpoint must be set directly on the radiator thermostat for each radiator of the zone.

Economy mode ☹

When Economy mode is activated, symbol ☹ appears on the display. The Economy setpoint is 3 °C lower than the Comfort setpoint (fixed value according to "Fil Pilote" data).

Stop mode ⏻

When this function is activated, symbol ⏻ appears on the display. All "Fil Pilote" stop signals are sent to all valid and active zones. In that case, all radiators of all zones are shut down.

Auto Timer AUTO

When Auto Timer mode is enabled, the changeover between the operating modes (Comfort and Economy) takes place automatically. There are 3 options for time switch setting: Individual days, 7 days, or days 5-2. You can select Comfort mode or Economy mode at 15-minutes intervals of the day. The 0:00 to 24:00 hour time bar allows the user to set the operating mode throughout the selected day(s).

Default value	Day/s	Comfort mode	Economy mode
	Mo (1) – Fr (5)	6:00 – 8:00 hr 17:00 – 22:00 hr	22:00 – 6:00 hr 8:00 – 17:00 hr
	Sa (6) – Su (7)	7:00 – 22:00 hr	22:00 – 7:00 hr





Refer to Operating Instructions CB1B1426en, section "Do you want to enter your own time switch?".

Holiday mode

When Holiday mode is activated, symbol  appears on the display. The number of days a user is absent can be adjusted by pressing touchkeys + and –. The "Fil Pilote" signal means that the order is sent to all valid and active zones. All zones are then controlled at a temperature level 7 or 8 °C below the Comfort setpoint (according to "Fil Pilote" data). This fixed value depends on the radiator thermostat.

Note: The radiator's commute switch must be set to "Automatic" to ensure the order from the programmer is used.

"Fil Pilote" 4-order standard signal

Order	Corresponding electric signals	
Comfort	No signal	
Economy	Full wave	
Protection	Half negative wave	
Stop	Half positive wave	

Maintenance note

The programmer is maintenance-free.

Disposal



The device is considered an electronic device for disposal in terms of the European Directive 2012/19/EU and may not be disposed of as domestic garbage.

- Dispose of the device through channels provided for this purpose.
- Comply with all local and currently applicable laws and regulations.

Technical data

 Power supply	Operating voltage	RDE100FP at L - N	AC 230 V +10/-15%
	Frequency		50 Hz
	Power consumption		4 VA
Control outputs	Control output "Fil Pilote" 1, 2, 3		AC 230 V, min. 0.5 A
Function data	Built-in room temperature sensor		
	Temperature calibration range		±3.0 °C
	Resolution of displays		
Environmental conditions	Temperature value		0.5 °C
	Operation		As per IEC 60721-3-3
	Climatic conditions		Class 3K5
	Temperature		0...50 °C
	Humidity		<95% r.h.
	Transport		As per IEC 60721-3-2
	Climatic conditions		Class 2K3
	Temperature		-25...60 °C
	Humidity		<95% r.h.
	Mechanical conditions		Class 2M2
	Storage		As per IEC 60721-3-1
	Climatic conditions		Class 1K3
Temperature		-25...60 °C	
Humidity		<95% r.h.	
Standards and directives	EU Conformity (CE)		A6V11399487 ^{*)}
	Safety class		II as per EN 60730-1, EN 60730-2-9
	Pollution class		II as per EN 60730-1
	Degree of protection of housing		IP30 as per EN 60529
Environmental compatibility	The product environmental declaration CE1E1420xx contains data on environmentally compatible product design and assessments (RoHS compliance, materials composition, packaging, environmental benefit, disposal).		
General	Connection terminals for		Solid wires or prepared stranded wires 2 x 1.5 mm ² or 1 x 2.5 mm ² (min. 0.5 mm ²)
	Weight		0.176 kg
	Color of housing front		RAL9003

*) The documents can be downloaded from <http://siemens.com/bt/download>.

Connection diagrams

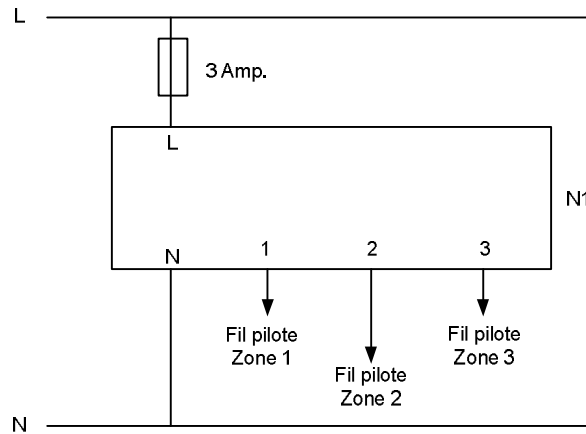

- N1 Programmer RDE100FP
- L Live, AC 230 V
- N Neutral conductor
- Q1 "Fil Pilote" output zone 1
- Q2 "Fil Pilote" output zone 2
- Q3 "Fil Pilote" output zone 3

Dimensions

Dimensions in mm

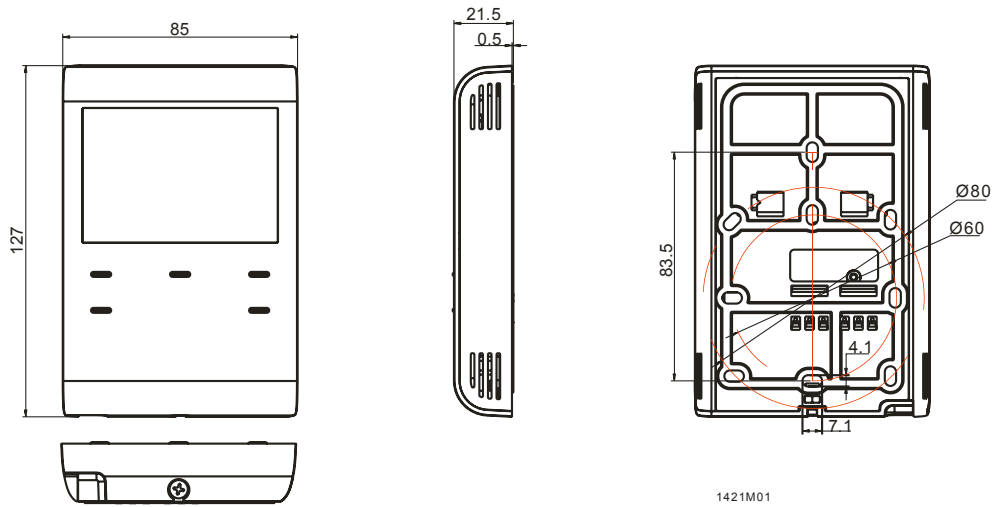

1421M01

Issued by
Siemens Switzerland Ltd.
Building Technologies Division
International Headquarters
Theilerstrasse 1a
CH-6300 Zug
Tel. +41 58 724 2424
www.siemens.com/buildingtechnologies

8 / 8

© Siemens Switzerland Ltd, 2013 - 2018
Technical specifications and availability subject to change without notice.