



RDE100.1FPRFS



RCR100FPRF

Wireless programmer with fil pilote and auto timer

RDE100.1 FPRFS

for heating systems

- For "Fil Pilote" 4-order system
- 3 "Fil Pilote" zones with time switch for each zone
- Choice of Comfort, Economy, Auto Timer and Stop mode
- Adjustable commissioning and control parameters
- Battery-powered programmer DC 3 V (RDE100.1FPRF)
- Mains-powered receiver AC 230 V (RCR100FPRF)

Use

The RDE100.1FPRFS is used as a heating programmer.

Typical applications:

- Apartments
- Commercial spaces
- Schools

For the control of the following pieces of equipment:

- "Fil Pilote" radiators
- "Fil Pilote" equipment

Functions

- Selection of operating mode with touchkey
- Setting the time switches (individual days, 7 days, or days 5-2)
- Display of current room temperature in °C or °F
- Touchkey lock (manually)
- Reloading factory settings for commissioning and control parameters
- Enabling operating mode for 3 zones
- Standalone wireless transmitter and receiver
- Wireless operating frequency 433 MHz

Type summary

Product No.	Stock number	Features
RDE100.1FPRFS	S55770-T284	Battery-powered programmer DC 3 V
RCR100FPRF	S55770-T287	"Fil Pilote" and receiver AC 230 V

Ordering

When ordering, please indicate product No. / stock number and description.

Product No.	Stock number	Description
RDE100.1FPRFS	S55770-T284	Wireless programmer set
RCR100FPRF	S55770-T287	Standalone "Fil Pilote" receiver (extra)

"Fil Pilote" radiators must be ordered separately.

The programmer consists of 3 parts:

- Plastic housing which accommodates the electronics, the operating elements and the room temperature sensor
- Mounting plate with screw terminals
- Table stand

The housing engages in the mounting plate and is secured with a screw. The optional table stand snaps onto the rear of the mounting plate.

The RCR100FPRF receiver consists of 2 parts:

- Plastic housing which accommodates the electronics
- Mounting plate with screw terminals

Operation and settings

RDE100.1FPRF

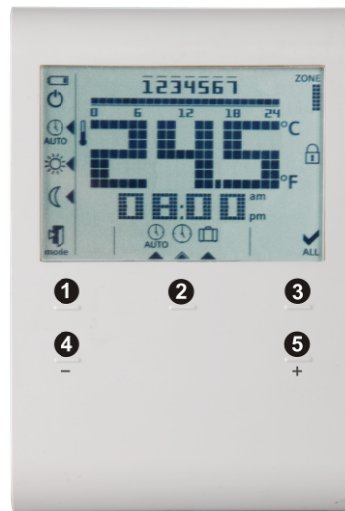

- 1) Touchkey for operating mode
- 2) Settings
- 3) Ok
- 4) Touchkey for decreasing a value
- 5) Touchkey for increasing a value

RCR100FPRF

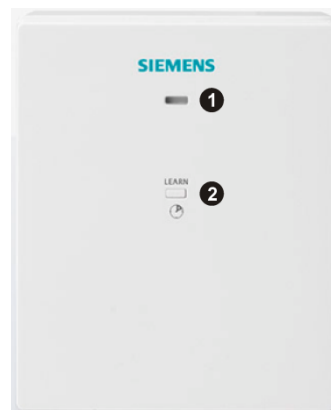

- 1) LED for indication of operating state
- 2) LEARN button

Display

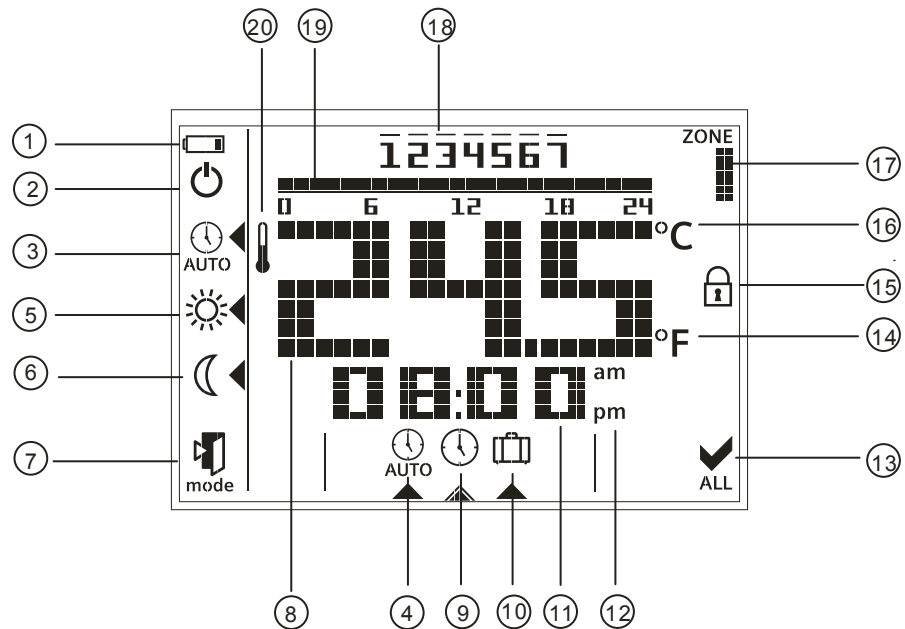

#	Symbol	Description	#	Symbol	Description
1		Indicating that batteries need to be replaced	11		Display of time of day
2		Stop mode	12	am pm	Morning: 12-hour format Afternoon: 12-hour format
3		Auto Timer mode	13		Confirmation
4		View and set time switches	14	°F	Room temperature in degrees Fahrenheit
5		Comfort mode	15		Touchkey lock activated
6		Economy mode	16	°C	Room temperature in degrees Celsius
7		Escape	17	ZONE 	Display of zone
8		Display of room temperature	18		Weekday 1 = Monday Weekday 7 = Sunday
9		Setting of weekday and time of day	19		Timer bar
10		Setting of Holiday mode	20		Current room temperature

In "Fil Pilote" systems, the temperature sensor used for the control is accommodated in the radiator itself. The internal sensor and the temperature display on the programmer are just for room temperature information. To ensure that this information is as accurate as possible, do not mount the programmer in niches or bookshelves, not behind curtains, not above or near heat sources, and not exposed to direct solar radiation. Mount it about 1.5 m above the floor.

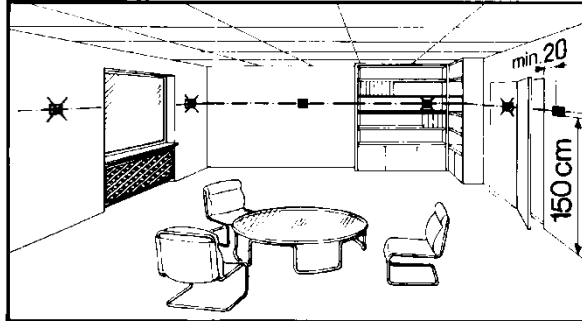

Mounting



- Mount the programmer in a clean and dry location without direct air flow from heating/cooling equipment, and not exposed to drip or splash water
- Install the receiver close to the controlled unit if possible
- Choose the location to ensure largely interference-free reception.

When mounting the receiver, observe the following:

- Do not mount in a control panel
- Do not mount on metallic surfaces
- Do not mount near electrical cables and equipment like PCs, TVs, microwaves, etc.
- Do not mount near larger metallic structures or constructional elements with fine metal meshes such as special glass or special concrete

Wiring

See Mounting Instructions CB1M1439xx enclosed with the programmer.



- Ensure that wiring, protection and earthing comply with local regulations
- Correctly size the cables to the programmer and radiators
- Use only radiators rated for AC 230 V

Warning!

No internal line protection for supply lines to external consumers.

Risk of fire and injury due to short-circuits!



- Adapt the line diameters as per local regulations to the rated value of the installed overcurrent protection device.
- The AC 230 V mains supply line must have an external circuit breaker with a rated current of no more than 10 A (this rated current depends on the radiator's capacity – influence on the receiver)
- If the programmer cannot accommodate all cables, power must be fed to the system via an external terminal block
- Disconnect from power supply before removing the unit from its mounting plate
- Make sure the receiver is not connected to power during wiring

Commissioning notes

Commissioning After power is applied, the unit carries out a reset during which all LCD segments flash, indicating that the reset is correctly made. After the reset, the unit is ready for commissioning by qualified HVAC personnel.

The control parameters of the programmer can be set to ensure optimum performance of the entire system (refer to Operating Instructions CB1B1427en, section "Do you want to change parameters?").

Sensor calibration If the temperature on the display does not agree with the room temperature effectively measured, the temperature sensor can be recalibrated. For that purpose, adjust parameter P04.

Note: The displayed temperature is for information only. Room temperature control is ensured by the thermostat inside the radiator.

Touchpad scanning rate Since this programmer uses touch technology and to minimize battery consumption, parameter P21 (adjustable from 0.25 to 1.5 seconds) is implemented for the user to adjust.

This means that when, for a certain time, the user does not touch the touchpad via the touchkeys, the unit operates in power saving mode and the touchpad is running at a scanning rate of 1 second.

(From the calculation – assuming 4 operations per day on the programmer, the estimated 1-second scanning rate results in a battery life of 1 year. If the user increases the scanning rate, the batteries' life is extended.)

Change of batteries If the battery symbol  appears, the batteries are almost exhausted and should be replaced. Use alkaline batteries type AAA.

LED indication on RCR100FPRF For the pairing process between transmitter and receiver, refer to Operating Instructions CB1B1427en, section "Do you want to pair transmitter and receiver?". The table below describes the behavior of the RCR100FPRF:

State of receiver	State of LED
Power up (or reset)	The red and green LEDs flash alternately for 5 seconds and then change to constantly red. Note: If the receiver was programmed before, it will immediately change to constantly red.
Learning mode Successful learning mode	The red and green LEDs flash alternately. If learning was successful, the green LED will flash for 10 minutes.
Signal ok and output status change	The green LED is lit. If the output state changes, the green LED flashes for 3 seconds and then changes back to constantly green.
Fails to receive wireless data	If the RCR100RF fails to receive wireless data, the red LED will start to flash after 125 minutes. If the RCR100RF signal is recovered, it will resume the previous LED state.

Operating notes

For each of the 3 zones, the RDE100.1FPRF provides Comfort, Economy and Auto Timer mode. The changeover between Comfort and Economy mode can be made either automatically by the time switch or by pressing the touchkey for the operating mode.

Comfort mode ☀

When Comfort mode is activated, symbol ☀ appears on the display. The Comfort setpoint must be set directly on the radiator thermostat for each radiator of the zone.

Economy mode ☾

When Economy mode is activated, symbol ☾ appears on the display. The Economy setpoint is 3 °C lower than the Comfort setpoint (fixed value according to "Fil Pilote" data).

Stop mode ⏻

When this function is activated, symbol ⏻ appears on the display. All "Fil Pilote" stop signals are sent to all valid and active zones. In that case, all radiators of all zones are shut down.

Auto Timer AUTO

When Auto Timer mode is enabled, the changeover between the operating modes (Comfort and Economy) takes place automatically. There are 3 options for time switch settings: Individual days, 7 days, or days 5-2. You can select Comfort or Economy mode at 15-minute intervals of the day. The 0:00 to 24:00 hour time bar allows you to set the operating mode throughout the selected day(s).

Default value	Day/s	Comfort mode	Economy mode
	Mo (1) – Fr (5)	6:00 – 8:00 hr 17:00 – 22:00 hr	22:00 – 6:00 hr 8:00 – 17:00 hr
	Sa (6) – Su (7)	7:00 – 22:00 hr	22:00 – 7:00 hr





Refer to Operating Instructions CB1B1427en, section "Do you want to enter your own time switch?".

Holiday mode

When Holiday mode is activated, symbol  appears on the display. The number of days a user is absent can be readjusted by pressing touchkeys + and -. The "Fil Pilote" signal means that the order is sent to all valid and active zones. All zones are then controlled at a temperature level 7 or 8 °C below the Comfort setpoint (according to "Fil Pilote" data). This fixed value depends on the radiator thermostat.

Note: The radiator's commute switch must be set to "Automatic" to ensure the order from the programmer is used.

"Fil Pilote" 4-order standard signal

Order	Corresponding electric signals	
Comfort	No signal	
Economy	Full wave	
Protection	Half negative wave	
Stop	Half positive wave	

Maintenance note

Programmer and receiver are maintenance-free.

Disposal



The device is considered an electronic device for disposal in terms of the European Directive 2012/19/EU and may not be disposed of as domestic garbage.

- Dispose of the device through channels provided for this purpose.
- Comply with all local and currently applicable laws and regulations.
- Dispose of empty batteries in designated collection points.

	⚠ WARNING
	<p>Risk of explosion due to fire or short-circuit, even if the batteries are empty</p> <p>Risk of injuries from by flying parts</p> <ul style="list-style-type: none"> • Do not allow the batteries to come into contact with water. • Do not charge the batteries. • Do not damage or destroy the batteries. • Do not heat the batteries to more than 85 °C.

	⚠ WARNING
	<p>Electrolyte leakage</p> <p>Chemical burns</p> <ul style="list-style-type: none"> • Only grasp damaged batteries using suitable protective gloves. • If electrolyte comes into contact with eyes, immediately rinse eyes with plenty of water. Consult a doctor.

Observe the following:

- Only replace batteries with batteries of the same type and from the same manufacturer.
- Observe the polarities (+/-).
- The batteries must be new and free from damage.
- Do not mixed new batteries with used batteries.
- Store, transport, and dispose of the batteries in accordance with local regulations, guidelines, and laws. Also observe information from the battery manufacturer.



Technical data of RDE100.1FPRF

	Power supply	<p>Operating voltage</p> <p>RDE100.1FPRF DC 3 V (2 x 1.5 V alkaline batteries AAA)</p> <hr/> <p>For battery life (RDE100.1FPRF), see below (alkaline batteries type AAA). Battery life calculation is based on touchpad scanning rate during idle time (assuming a user presses 4 touchkeys per day):</p> <table style="width: 100%; border-collapse: collapse;"> <tr> <td style="width: 50%;">Scanning rate 0.25 s</td> <td style="width: 50%;">311 days battery life</td> </tr> <tr> <td>Scanning rate 0.5 s</td> <td>322 days battery life</td> </tr> <tr> <td>Scanning rate 1 s (default)</td> <td>357 days battery life</td> </tr> <tr> <td>Scanning rate 1.5 s</td> <td>377 days battery life</td> </tr> </table>	Scanning rate 0.25 s	311 days battery life	Scanning rate 0.5 s	322 days battery life	Scanning rate 1 s (default)	357 days battery life	Scanning rate 1.5 s	377 days battery life
	Scanning rate 0.25 s	311 days battery life								
Scanning rate 0.5 s	322 days battery life									
Scanning rate 1 s (default)	357 days battery life									
Scanning rate 1.5 s	377 days battery life									
Function data	<p>Built-in room temperature sensor</p> <p>Temperature calibration range ±3.0 °C</p> <hr/> <p>Resolution of settings and displays</p> <p>Temperature value displays 0.5 °C</p>									
Environmental conditions	<p>Operation As per IEC 60721-3-3</p> <p>Climatic conditions Class 3K5</p> <p>Temperature 0...50 °C</p> <p>Humidity <95% r.h.</p>									

	Transport	As per IEC 60721-3-2
	Climatic conditions	Class 2K3
	Temperature	-25...60 °C
	Humidity	<95% r.h.
	Mechanical conditions	Class 2M2
	Storage	As per IEC 60721-3-1
	Climatic conditions	Class 1K3
	Temperature	-25...60 °C
	Humidity	<95% r.h.
Standards and directives	EU Conformity (CE)	CB1T1420xx ^{*)}
	Safety class	II as per EN 60730-1, EN 60730-2-9
	Pollution class	II as per EN 60730
Environmental compatibility	Degree of protection of housing	IP30 as per EN 60529
	The product environmental declaration CE1E1420xx ^{*)} contains data on environmentally compatible product design and assessments (RoHS compliance, materials composition, packaging, environmental benefit, disposal).	
General	Connection terminals for	Solid wires or prepared stranded wires 2 x 1.5 mm ² or 1 x 2.5 mm ² (Min. 0.5 mm ²)
	Weight	0.176 kg
	Color of housing front	RAL9003

*) The documents can be downloaded from <http://siemens.com/bt/download>.

Technical data of RCR100FPRF

 Power supply	Operating voltage	AC 230 V +10/-15%
	RCR100FPRF at L - N	
	Frequency	50 Hz
	Power consumption	4 VA
<hr/>		
Control outputs 	Control output "Fil Pilote"	AC 230 V, Min. 0.5 A
<hr/>		
Environmental conditions	No internal fuse.	
	External preliminary protection with max. C 10 A circuit breaker in the supply lines required under all circumstances.	
	<hr/>	
	Operation	As per IEC 60721-3-3
	Climatic conditions	Class 3K5
	Temperature	0...50 °C
	Humidity	<95% r.h.
	<hr/>	
	Transport	As per IEC 60721-3-2
	Climatic conditions	Class 2K3
Temperature	-25...60 °C	
Humidity	<95% r.h.	
Mechanical conditions	Class 2M2	
<hr/>		
Standards and directives	Storage	As per IEC 60721-3-1
	Climatic conditions	Class 1K3
	Temperature	-25...60 °C
	Humidity	<95% r.h.
<hr/>		
EU Conformity (CE)	CB1T1420xx ^{*)}	
Environmental compatibility	Safety class	II as per EN 60730-1, EN 60730-2-9
	Pollution class	II as per EN 60730-1
	Degree of protection of housing	IP30 as per EN 60529
General	The product environmental declaration CE1E1420xx ^{*)} contains data on environmentally compatible product design and assessments (RoHS compliance, materials composition, packaging, environmental benefit, disposal).	
	<hr/>	
	Connection terminals for	Solid wires or prepared stranded wires 2 x 1.5 mm ² or 1 x 2.5 mm ² (Min. 0.5 mm ²)
	<hr/>	
	Weight	0.138 kg
<hr/>		
Color of housing front	RAL9003	

*) The documents can be downloaded from <http://siemens.com/bt/download>.

Connection diagrams

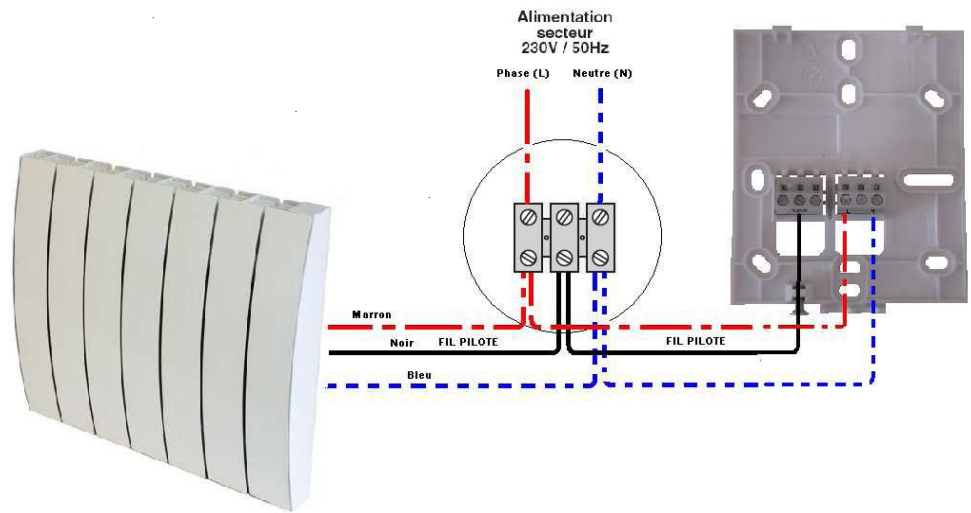

Dimensions

Dimensions in mm

Programmer RDE100.1FPRF

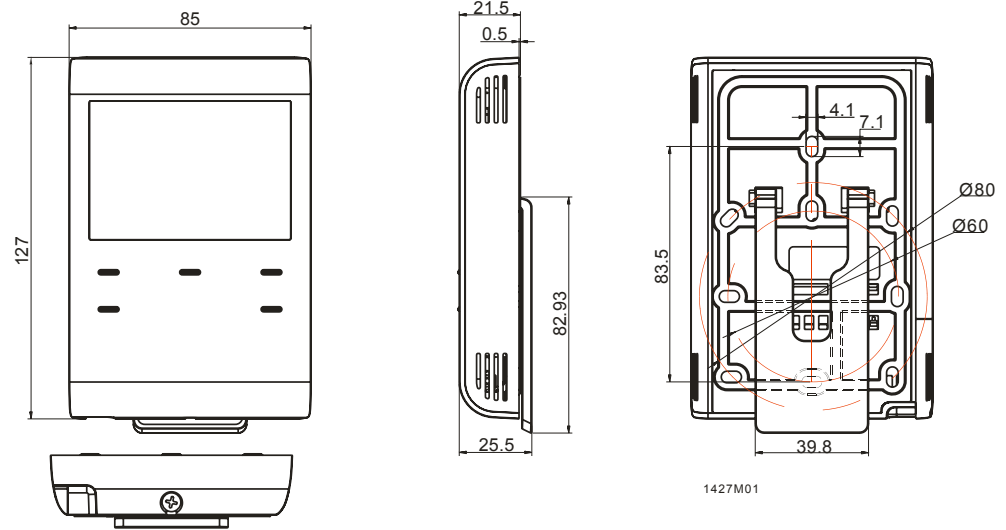

Receiver RCR100FPRF

